

### 3. Temperature unit setting:

Press the SET button to F1, press the left and right buttons to switch between Celsius and Fahrenheit. C:Celsius F:Fahrenheit

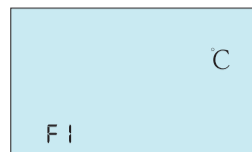

### 4.Mode setting:

Press the SET button to F2, press the left and right buttons to switch the working mode.

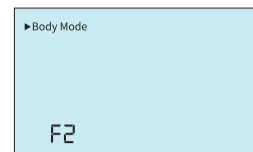

### 5. Alarm temperature setting:

Press the SET button to F3, it is the alarm setting state of the body mode. Press the left and right buttons to switch the alarm temperature between 37.0~38.0. The default is 37.3 C.

Note: The alarm temperature is only valid in the body mode.

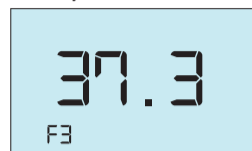

### 6. Volume setting:

Press the SET button to F4, it is the volume setting state. Press the left and right buttons to adjust the volume. The more parentheses behind the small speaker, the greater the volume, and the disappearance of the small speaker represents mute.

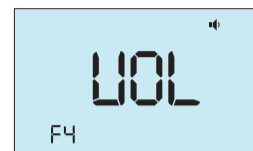

### 7. Backlight setting:

Press the SET button to F5, it is the backlight setting state. Press the left and right buttons to turn the backlight on or off.

ON: turn on the backlight  
OFF: turn off the backlight

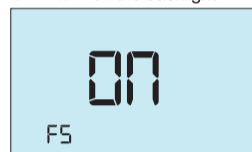

### 8. Language setting:

Press the SET button to F6, press the left and right buttons to switch the language of the voice broadcast.

CH: Chinese EN: English

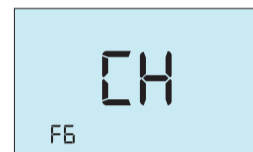

### 9. Output signal setting:

Press the SET button to F7, press the left and right buttons to switch the output signal type. S1 represents the switch mode and S2 represents the pulse mode. For more instructions about output signals, please refer to output signal user guide.

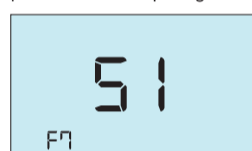

### 10.USB connection:

Connect to the computer with Type C USB cable, open the software on the computer, you can connect with the device and store the measurement results in real time. For more instructions, please refer to software user guide.

### 11. Battery installation:

Open the battery cover and install the new battery correctly according to the battery polarity.

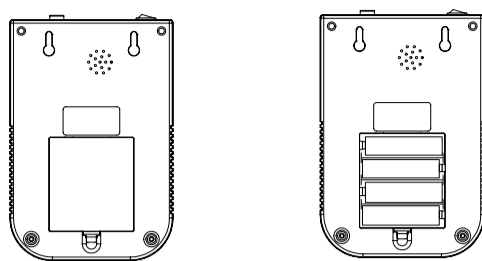

### 12. Install method: nail hook, bracket fixing

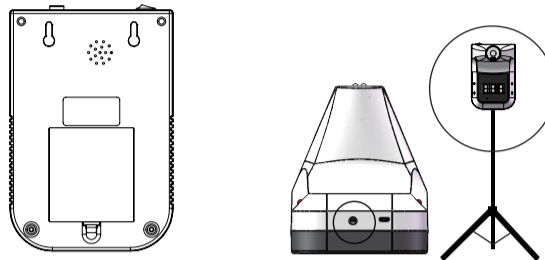

1.Nail hook

2.Bracket fixing

### 6. Warnings

- 1.It is the user's responsibility to ensure the electromagnetic compatibility environment of the device so that the device can work normally.
- 2.It is recommended to evaluate the electromagnetic environment before using the device.
- 3.When changing the operating environment, the device must be left to stand for more than 30 minutes.
- 4.Please measure the forehead to the thermometer.
- 5.Please avoid direct sunlight when using outdoors.
- 6.Keep away from air conditioners, fans, etc.
- 7.Please use qualified, safety-certified batteries, unqualified batteries or non-rechargeable batteries used may cause fire or explosion.

CE FC RoHS  
Made in China

# User Guide

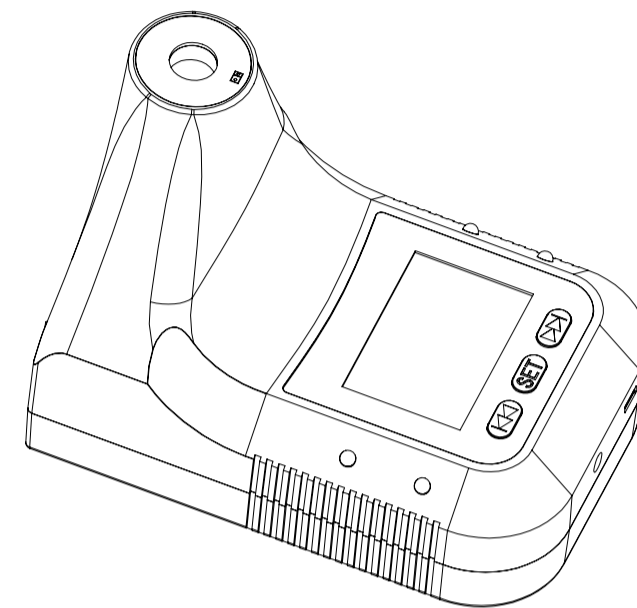

### 1.Introduction

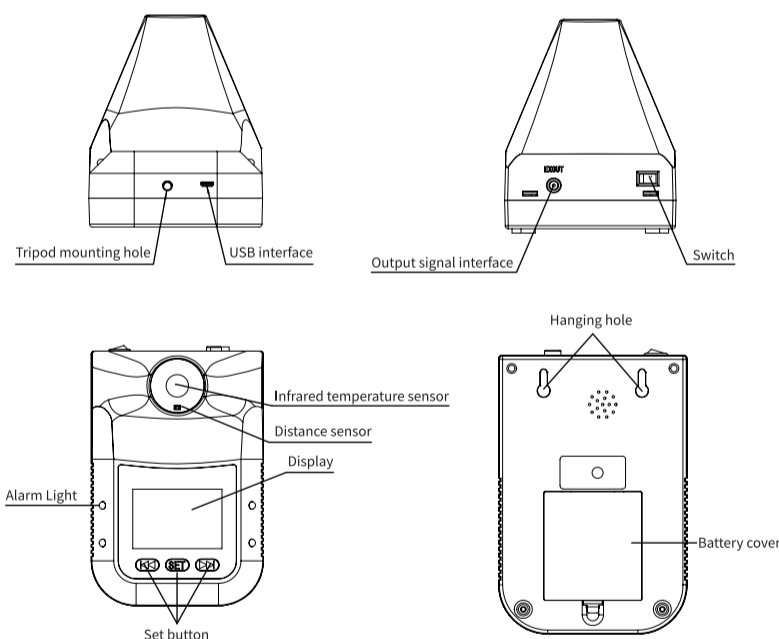

### 2.Specification

1. Accuracy:  $\pm 0.2$  degrees (35~42 C, place it in the operating environment for 30 minutes before use)
2. Alarm Function: abnormal automatic alarm, flash + sound alarm for about 10 seconds
3. Measuring distance: 5cm~10cm automatic measurement
4. Display: LCD display
5. Transmission interface: USB Type C
6. Adaptable power supply: 4 AA batteries (external power supply and internal power supply can be switched)
7. Install method: nail hook, bracket fixing
8. Environment temperature: 10 C~40 C (recommended 15 C~35 C)
9. Measuring range: 0~50 C
10. Response time: 0.5s
11. Standby: 30s automatic standby during non-working hours
12. Input: DC 5V 500mA
13. Weight: 303g
14. Dimensions: 170X115X140mm
15. Counting capacity: 9999 times

### 3.Display Description

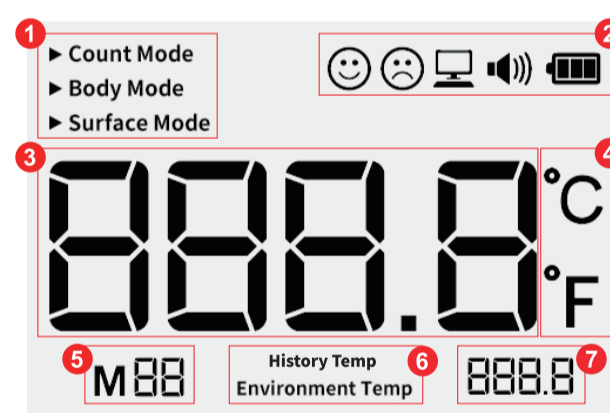

- 1 Working mode: count mode, body mode, surface mode.
- 2 Status indication: expression, USB connection status, volume, power.
- 3 Measurement result: temperature status or count status.
- 4 Temperature unit: Celsius or Fahrenheit.
- 5 Setting item or historical record: M\*\* indicates the historical record number; F\* indicates the setting item number.
- 6 History Temp or Environment Temp.
- 7 Environment temperature status.

### 4.State description

**1.Standby:**  
The backlight is turned off and the temperature remains displayed. (Fig. 1)

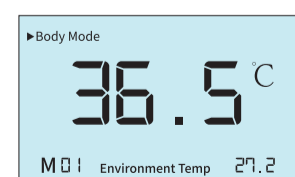

(Fig. 1)

**2. Insufficient power:**  
The display indicates that the battery is empty and the icon flashes. (Fig. 2)

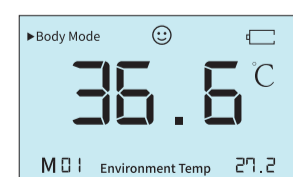

(Fig. 2)

**3.Normal temperature:**  
Flashing green lights on both sides

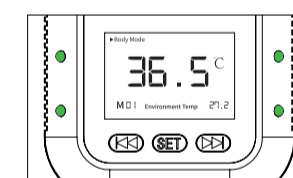

(Fig. 3)

**4.Abnormal temperature:**  
Flashing red lights on both sides

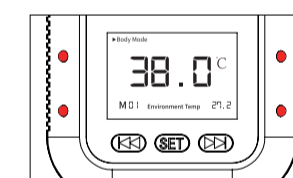

(Fig. 4)

**5.Out of range(in body mode)**  
'Lo': Ultra-low temperature than 35 degrees Celsius (Fig. 5)  
'Hi': Ultra-high temperature than 42 degrees Celsius (Fig. 6)

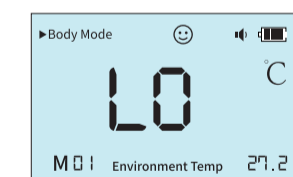

(Fig. 5)

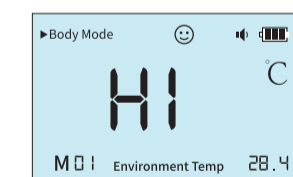

(Fig. 6)

### 5.Operation Instruction

**1.Temperature measurement:**  
Front of the thermometer, approach it within 5-10cm. (Fig. 7)

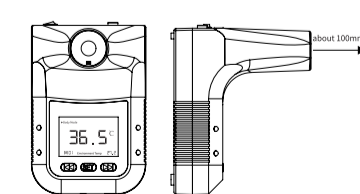

(Fig. 7)

**2.History temperature query:**  
Press the left and right buttons to query the historical temperature, M\*\* represents the current historical temperature. The device currently supports up to 30 historical temperatures.

